

Ceiling-mounted ventilation system

User manual and installation
instructions

I94CAQ6N0B

Table of contents

INFORMATION FOR USE

1	Safety	2
2	Preventing material damage	5
3	Environmental protection and saving energy	5
4	Operating modes	5
5	Familiarising yourself with your appliance	7
6	Before using for the first time	7
7	Basic operation	7
8	Home Connect	9
9	Hob-based hood control	10
10	Cleaning and servicing	10
11	Troubleshooting	13
12	Disposal	14
13	Customer Service	14
14	Accessories	14
15	Declaration of Conformity	15
16	INSTALLATION INSTRUCTIONS	15
16.4	Secure installation	16

1 Safety

Observe the following safety instructions.

1.1 General information

- Read this instruction manual carefully.
- Keep the instruction manual and the product information safe for future reference or for the next owner.
- Do not connect the appliance if it has been damaged in transit.

1.2 Intended use

This appliance is designed only to be built into kitchen units. Read the special installation instructions.

The appliance can only be used safely if it is correctly installed according to the safety instructions. The installer is responsible for ensuring that the appliance works perfectly at its installation location.

Only use this appliance:

- For extracting cooking vapour.
- in private households and in enclosed spaces in a domestic environment.
- up to an altitude of max. 2000 m above sea level.

Do not use the appliance:

- With an external timer.

1.3 Restriction on user group

This appliance may be used by children aged 8 or over and by people who have reduced physical, sensory or mental abilities or inadequate experience and/or knowledge, provided that they are supervised or have been instructed on how to use the appliance safely and have understood the resulting dangers.

Do not let children play with the appliance. Children must not perform cleaning or user maintenance unless they are at least 15 years old and are being supervised.

Keep children under the age of 8 years away from the appliance and power cable.

1.4 Safe use

WARNING – Risk of suffocation!

Children may put packaging material over their heads or wrap themselves up in it and suffocate.

- ▶ Keep packaging material away from children.
- ▶ Do not let children play with packaging material.

Children may breathe in or swallow small parts, causing them to suffocate.

- ▶ Keep small parts away from children.
- ▶ Do not let children play with small parts.

⚠ WARNING – Risk of poisoning!

Risk of poisoning from flue gases being drawn back in. Room-air-dependent heat-producing appliances (e.g. gas, oil, wood or coal-operated heaters, continuous flow heaters or water heaters) obtain combustion air from the room in which they are installed and discharge the exhaust gases into the open through an exhaust gas system (e.g. a chimney). With the extractor hood switched on, air is extracted from the kitchen and the adjacent rooms. Without an adequate supply of air, the air pressure falls below atmospheric pressure. Toxic gases from the chimney or the extraction shaft are sucked back into the living space.

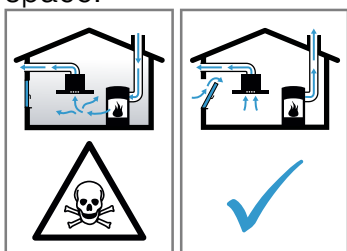

- ▶ Always ensure adequate fresh air in the room if the appliance is being operated in exhaust air mode at the same time as a room-air-dependent heat-producing appliance is being operated.
- ▶ It is only possible to safely operate the appliance if the pressure in the room in which the heating appliance is installed does not fall below 4 Pa (0.04 mbar). This can be achieved whenever the air needed for combustion is able to enter through openings that cannot be sealed, for example in doors, windows, incoming/exhaust air wall boxes or by other technical means. An incoming/exhaust air wall box alone is not sufficient to ensure compliance with the limit.
- ▶ In any case, consult your responsible chimney sweep. They are able to assess the house's entire ventilation setup and will suggest the suitable ventilation measures to you.
- ▶ Unrestricted operation is possible if the appliance is operated exclusively in circulating-air mode.

⚠ WARNING – Risk of fire!

Fatty deposits in the grease filters may catch fire.

- ▶ Never operate the appliance without a grease filter.
- ▶ Clean the grease filters regularly.
- ▶ Never work with naked flames close to the appliance (e.g. flambéing).
- ▶ Do not install the appliance near a solid fuel heating appliance (e.g. wood- or coal-burning) unless the heating appliance has a sealed, non-removable cover. There must be no flying sparks.

Hot oil or grease ignites very quickly.

- ▶ Always supervise hot oil and fat.
- ▶ Never extinguish burning oil or fat with water. Switch off the cooking zone. Extinguish flames carefully using a lid, fire blanket or something similar.

When gas burners are in operation without any cookware placed on them, they can build up a lot of heat. A ventilation appliance installed above the cooker may become damaged or catch fire.

- ▶ Only operate the gas burners with cookware on them.

Operating multiple gas hobs at the same time generates a great deal of heat. A ventilation appliance installed above the cooker may become damaged or catch fire.

- ▶ Only operate the gas hobs with cookware on them.
- ▶ Select the highest fan setting.
- ▶ Never operate two gas hobs simultaneously on the highest flame for longer than 15 minutes. Two gas hobs correspond to one large burner.
- ▶ Never operate large burners of more than 5 kW with the highest flame for longer than 15 minutes, e.g. a wok.

⚠ WARNING – Risk of burns!

The accessible parts of the appliance become hot during operation.

- ▶ Never touch these hot parts.
- ▶ Keep children at a safe distance.

The appliance becomes hot during operation.

- ▶ Allow the appliance to cool down before cleaning.

⚠ WARNING – Risk of injury!

Components inside the appliance may have sharp edges.

- ▶ Carefully clean the appliance interior. Items placed on the appliance may fall off.
- ▶ Do not place any objects on the appliance. Changes to the electrical or mechanical assembly are dangerous and may lead to malfunctions.

- ▶ Do not make any changes to the electrical or mechanical assembly.

The filter cover may swing out.

- ▶ Open the filter cover slowly.
- ▶ Take hold of the filter cover after opening until it no longer swings out.
- ▶ Close the filter cover slowly.

Risk of injury when opening and closing the hinges.

- ▶ Keep your hands away from the hinges. The light emitted by LED lights is very dazzling, and can damage the eyes (risk group 1).
- ▶ Do not look directly into the switched-on LED lights for longer than 100 seconds.

⚠ WARNING – Risk of serious harm to health!

Children may swallow batteries.

- ▶ Keep batteries out of the reach of children.
- ▶ Swallowing can lead to chemical burns, perforation of soft tissue, and death. Severe burns can occur within 2 hours of ingestion. Seek medical attention immediately.

⚠ WARNING – Risk of injury!

Children may swallow batteries.

- ▶ Keep batteries out of the reach of children.
- ▶ Keep an eye on any children when you are replacing batteries.

Batteries may explode.

- ▶ Do not charge the batteries.
- ▶ Do not short-circuit the batteries.
- ▶ Do not throw batteries into a fire.

Risk of falling when working on the appliance

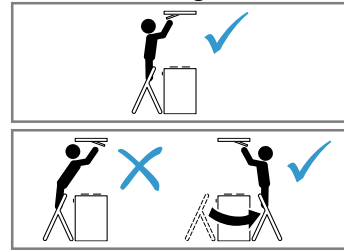

- ▶ Use a stable stepladder.
- ▶ Do not lean over the hob.
- ▶ Do not step on the hob or the work surface.

If the appliance is operated by another person via the Home Connect app during cleaning, this increases the risk of injury.

- ▶ Before cleaning, disconnect the appliance from the Home Connect app.

⚠ WARNING – Risk of electric shock!

If the appliance or the power cord is damaged, this is dangerous.

- ▶ Never operate a damaged appliance.
 - ▶ Never pull on the power cord to unplug the appliance. Always unplug the appliance at the mains.
 - ▶ If the appliance or the power cord is damaged, immediately unplug the power cord or switch off the fuse in the fuse box.
 - ▶ Call customer services. → *Page 14*
- Improper repairs are dangerous.
- ▶ Repairs to the appliance should only be carried out by trained specialist staff.
 - ▶ Only use genuine spare parts when repairing the appliance.
 - ▶ If the power cord of this appliance is damaged, it must be replaced by trained specialist staff.

An ingress of moisture can cause an electric shock.

- ▶ Before cleaning, pull out the mains plug or switch off the fuse in the fuse box.
- ▶ Do not use steam- or high-pressure cleaners to clean the appliance.

⚠ WARNING – Risk of explosion!

Highly caustic alkaline or highly acidic cleaning agents in conjunction with aluminium parts in the interior of the appliance may cause explosions.

- ▶ Never use highly caustic alkaline or highly acidic cleaning agents. In particular, do not use commercial or industrial cleaning agents in conjunction with aluminium parts, e.g. grease filter on extractor hoods.

⚠ WARNING – Risk of fire!

Fatty deposits in the grease filters may catch fire.

- ▶ Clean the grease filters regularly.

⚠ WARNING – Risk of injury!

Improper repairs are dangerous.

- ▶ Repairs to the appliance should only be carried out by trained specialist staff.
- ▶ If the appliance is defective, call Customer Service.

→ "Customer Service", Page 14

⚠ WARNING – Risk of electric shock!

Penetrating moisture may cause an electric shock.

- ▶ Do not use wet sponge cloths.

2 Preventing material damage

2.1 Avoiding material damage

ATTENTION!

Condensate may cause corrosion damage.

- ▶ To prevent condensation from building up, switch on the appliance during cooking.

If moisture gets into the controls, this may result in damage.

- ▶ Never clean controls with a wet cloth.

Incorrect cleaning damages the surfaces.

- ▶ Follow the cleaning instructions.
- ▶ Do not use harsh or abrasive detergents.
- ▶ Clean stainless steel surfaces in the direction of the finish only.
- ▶ Never clean controls with stainless steel cleaners.

Condensation that flows back in may damage the appliance.

- ▶ The air extraction duct must be installed with a gradient of at least 1° from the appliance.

If you put incorrect stress on the design elements, they may break off.

- ▶ Do not pull design elements.
- ▶ Do not place objects on the design elements or hang objects from them.

Leaking batteries may damage the remote control.

- ▶ Remove the batteries if you are not using the remote control.
- ▶ Safely dispose of empty or defective batteries in an environmentally friendly manner.

There is a risk of surface damage if you do not peel off the protective film.

- ▶ Remove the protective film from all parts of the appliance before using for the first time.

Painted surfaces are easily damaged.

- ▶ Follow the cleaning instructions.
→ "Cleaning the appliance", Page 11
- ▶ Ensure that the painted surfaces are not scratched.

3 Environmental protection and saving energy

3.1 Disposing of packaging

The packaging materials are environmentally compatible and can be recycled.

- ▶ Sort the individual components by type and dispose of them separately.

3.2 Saving energy

If you follow these instructions, your appliance will use less power.

Adjust the fan speed to the amount of steam produced during cooking.

- The lower the fan speed, the less energy is consumed.
Only use the intensive mode as required.

If cooking produces large amounts of steam, select a higher fan speed in good time.

- The odours are distributed around the room less.

Switch off the lighting if it is no longer required.

- When the lighting is switched off, it does not consume any energy.

Clean or replace the filters at regular intervals.

- The effectiveness of the filter is retained.

Put the cooking lid on.

- The cooking vapours and condensation are reduced.

Only use the additional functions if required.

- Switching off additional functions reduces power consumption.

4 Operating modes

You can use your appliance in air extraction mode or circulating-air mode.

The saturation indicator must be adjusted to the selected operating mode and the filters used.

→ "Setting the saturation indicator", Page 8

4.1 Air extraction mode

The air which is drawn in is cleaned by the grease filters and conveyed to the exterior by a pipe system.



The air must not be discharged into a flue that is used for exhausting fumes from appliances burning gas or other fuels (not applicable to appliances that only discharge the air back into the room).

- If the exhaust air is to be conveyed into a non-functioning smoke or exhaust gas flue, you must obtain the consent of the heating engineer responsible.
 - If the exhaust air is conveyed through the external wall, a telescopic duct should be used.
-

4.2 Air recirculation

The air which is drawn in is cleaned by the grease filters and an odour filter, and conveyed back into the room.



To bind odours in air recirculation mode, you must install an odour filter. The different options for operating the appliance in air circulation mode can be found in our catalogue. Alternatively, ask your dealer. The required accessories are available from specialist retailers, from our after-sales service or from the online shop.

→ "Accessories", Page 14

5 Familiarising yourself with your appliance

5.1 Controls

You can use the controls to configure all functions of your appliance and to obtain information about the operating status.

Tip: Align the remote control as precisely as possible to the infrared receiver for the LED display.

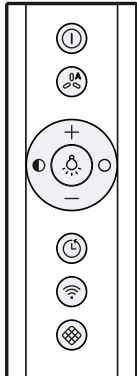

Ⓚ	Switch the appliance on or off
🌀	Switching automatic mode ¹ on or off
+	Increase the fan setting
-	Decrease the fan setting
💡	Switch the lighting on or off
◐	Reduce the brightness
◑	Increase the brightness
¹ Depending on the appliance specifications	

Ⓚ	Switch the fan run-on on or off
📶	Home Connect Establishing a connection
🌀	Reset the filter saturation indicator
¹ Depending on the appliance specifications	

5.2 LED display

Die LED-Anzeige zeigt eingestellte Werte und Funktionen.

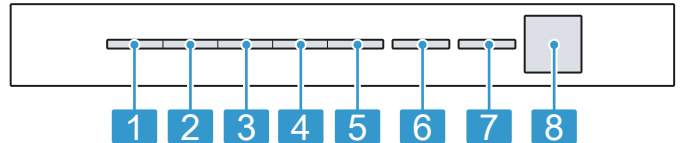

1	Fan setting 1/grease filter saturation display
2	Fan setting 2/odour filter saturation indicator
3	Fan setting 3
4	Intensive mode 1
5	Intensive mode 2
6	Automatic mode ¹ /fan run-on time/interval ventilation
7	Home Connect
8	Infrared receiver
¹ Depending on the appliance specifications	

6 Before using for the first time

Configure the settings for initial start-up. Clean the appliance and accessories.

6.1 Setting an operating mode

Your appliance is set to air extraction mode by default.

Note: When using it in circulating-air mode, you require additional accessories.

- ▶ When using it in circulating-air mode, set the operating mode.

7 Basic operation

7.1 Switching on the appliance

Requirement: Align the remote control as precisely as possible to the infrared receiver for the LED display.

- ▶ Press Ⓚ to switch on the appliance.
- ✓ The appliance starts at fan setting 2.
- ✓ The LED for the set fan setting lights up in the LED display.

7.2 Switching off the appliance

Switch the appliance off when you are not using it.

- ▶ Press Ⓚ to switch the appliance off.
- ✓ The appliance switches off. Any functions currently in progress are cancelled.

7.3 Selecting a fan setting

- ▶ Press + or -.
- ✓ The LED for the set fan setting lights up in the LED display.

7.4 Switching on intensive mode

If particularly strong odours or vapours develop, you can use intensive mode.

1. + so oft drücken, bis in der LED-Anzeige die LED 4 für die Intensivstufe 1 leuchtet.
 2. + so oft drücken, bis in der LED-Anzeige die LED 5 für die Intensivstufe 2 leuchtet.
- ✓ After approx. 6 minutes, the appliance automatically switches to fan setting 3.

7.5 Switching off intensive mode

- ▶ To select a fan setting of your choice, press —.

7.6 Switching on the fan run-on

- ▶ Press ☺.
- ✓ LED 1 for the fan setting lights up in the LED display. LED 6 flashes for the fan run-on.
- ✓ The appliance switches off automatically after approx. 10 minutes.

7.7 Switching off the fan run-on

- ▶ Press ☺.
- ✓ This immediately stops the fan run-on.
- ✓ The appliance switches to the fan setting that was previously selected.

7.8 Intermittent ventilation

In order to regularly ventilate your kitchen, you can use the interval ventilation. With interval ventilation, the ventilation system switches on and off in the selected setting for the selected time.

Note: This function is only available in the Home Connect app.

If the interval ventilation is switched on, LED 6 continuously flashes in the LED display for the interval ventilation and the LED for the selected fan setting lights up. As soon as the ventilation time ends, the LED for the fan setting you have selected goes out. LED 6 continues to flash.

7.9 Switching on automatic mode¹

The optimum fan setting is set automatically using a sensor.

- ▶ Press 🌬️.
- ✓ In the LED display, LED 6 lights up for automatic mode.

7.10 Switch off automatic mode¹

- ▶ Press 🌬️.
- ✓ The appliance switches to the fan setting that was previously set.
- ✓ The ventilation is automatically ended when the sensor detects no further change in the room air quality.
- ✓ Automatic mode runs for a maximum of four hours.

7.11 Sensor sensitivity¹

In automatic mode, a sensor in the appliance detects the intensity of the cooking odours and roasting odours. Depending on the setting of the sensor sensitivity, the optimum fan setting is automatically switched on.

If the sensor control reacts too weakly or too strongly, you can change the setting for the sensor sensitivity.

- Default setting: Fan setting 3
- Lowest setting: Fan setting 1
- Highest setting: Fan setting 5

7.12 Setting the sensor sensitivity¹

Requirement: The appliance is switched off.

1. Press and hold ⓪ and 🌬️ for approx. 3 seconds.
 2. Press + or — to change the setting.
To cancel the setting, press ⓪.
 3. To save the setting, press and hold ⓪ and 🌬️ for approx. three seconds.
Or wait approx. 10 seconds until the setting is saved automatically.
- ✓ A signal tone sounds as soon as the selected setting is saved.

7.13 Saturation indicator

If the grease filters or odour filters are saturated, corresponding symbols flash after the appliance is switched off.

Note: You can set the saturation indicator in the Home Connect app depending on the filter used.

Clean the saturated grease filters and, in doing so, observe the cleaning instructions in these instructions. Change the saturated odour filters and observe the instructions in the accompanying instructions. If odour filters can be regenerated, follow the instructions in the accompanying instructions.

7.14 Setting the saturation indicator¹

The saturation indicator must be adjusted depending on the filter used.

Requirement: The appliance is switched off.

1. Press and hold ⓪ and 🌀 for approx. three seconds.
 - To set circulating-air mode (non-regenerable filter), press +/— until LED 2 lights up in the LED display.
 - To set circulating-air mode (non-regenerable filter), press +/— until LED 3 lights up in the LED display.
 - To convert the electronic control back to operation without the air recirculation filter, press +/— until LED 1 lights up on the LED display.
 2. To save the setting, press and hold ⓪ and 🌀 for approx. three seconds.
Or wait approx. 10 seconds until the setting is saved automatically.
To cancel the setting, press ⓪.
- ✓ A signal tone sounds as soon as the selected setting is saved.

¹ Depending on the appliance specifications

7.15 Resetting the saturation indicator

After cleaning the grease filter or after changing the odour filter, the saturation indicator can be reset.

Requirements



- After the appliance has been switched off, LED 1 flashes in the LED display for the grease filter saturation display and/or LED 2 flashes for the saturation indicator for the odour filter.
- A signal sounds repeatedly.
 - ▶ Press .
 - ✓ The saturation indicator is reset.

7.16 Switching on the lighting

- ▶ Press  to switch on the lighting.

Note: Colour temperature settings are available in the Home Connect app provided the appliance has this function.

7.17 Setting the brightness







- ▶ Press and hold  or .

Note: Colour temperature settings are available in the Home Connect app provided the appliance has this function.

7.18 Switching on the button tone

The button tones can be switched on.

Requirement: The appliance is switched off.







1. Press and hold  and  for approx. three seconds.
 - ✓ In the LED display, the LED for the setting that is currently selected lights up.
2. Press  or  until LED 1 lights up in the LED display.
 - To cancel the setting, press .
3. To save the setting, press and hold  and  for approx. three seconds.
 - Or wait approx. 10 seconds until the setting is saved automatically.
 - ✓ A signal tone sounds as soon as the selected setting is saved.

7.19 Switching the button tone off

The button tones can be switched off.

Note: Signal tones for the appliance are always switched on and cannot be switched off.

Requirement: The appliance is switched off.

1. Press and hold  and  for approx. three seconds.
 - ✓ In the LED display, the LED for the setting that is currently selected lights up.
2. Press  or  until LED 2 lights up in the LED display.
 - To cancel the setting, press .
3. To save the setting, press and hold  and  for approx. three seconds.
 - Or wait approx. 10 seconds until the setting is saved automatically.
 - ✓ A signal tone sounds as soon as the selected setting is saved.

8 Home Connect

This appliance is network-capable. Connecting your appliance to a mobile device lets you control its functions via the Home Connect app, adjust its basic settings and monitor its operating status.

The Home Connect services are not available in every country. The availability of the Home Connect function depends on the availability of Home Connect services in your country. You can find information about this at: www.home-connect.com.

The Home Connect app guides you through the entire login process. Follow the instructions in the Home Connect app to configure the settings.

If the appliance is not connected to your home network, it functions as an appliance with no network connection and can still be operated via the display.

Tip: Please also follow the instructions in the Home Connect app.

Notes

- Please note the safety precautions in this instruction manual and make sure that they are also observed when operating the appliance via the Home Connect app.
 - "Safety", Page 2
- Operating the appliance on the appliance itself always takes priority. During this time it is not possible to operate the appliance using the Home Connect app.

- In networked standby mode, the appliance requires a maximum of 2 W.
- If you need your device's MAC address to connect to your home network, you can find this next to the rating plate. → Page 14

8.1 Setting up Home Connect

Requirements



- The appliance is switched off.
 - You have a mobile device with a current version of the iOS or Android operating system, e.g. a smartphone.
 - The mobile device and the appliance are within range of your home network's Wi-Fi signal.
1. Download the Home Connect app.
 2. Open the Home Connect app and scan the following QR code.



3. Follow the instructions in the Home Connect app.

8.2 Resetting the connection

Saved connections to the home network and to Home Connect can be reset.

- ▶ Press and hold  and  until LED 7 goes out in the LED display.
- ✓ An audible signal sounds.

8.3 Software update

Your appliance's software can be updated using the software update function, e.g. for the purposes of optimisation, troubleshooting or security updates. To do this, you must be a registered Home Connect user, have installed the app on your mobile device and be connected to the Home Connect server. As soon as a software update is available, you will be informed via the Home Connect app and will be able to start the software update via the app. Once the update has been successfully downloaded, you can start installing it via the Home Connect app if you are in your home network (Wi-Fi). The Home Connect app informs you once installation is successful.

Notes

- The software update consists of two steps.
 - The first step is the download.
 - The second step is the installation on your appliance.
- You can continue to use your appliance as normal while updates are downloading. Depending on your personal settings in the app, software updates can also be set to download automatically.
- Installation takes a few minutes. You cannot use your appliance during installation.

- We recommend that you install security updates as soon as possible.

8.4 Remote diagnostics

Customer Service can use Remote Diagnostics to access your appliance if you contact them, have your appliance connected to the Home Connect server and if Remote Diagnostics is available in the country in which you are using the appliance.

Tip: For further information and details about the availability of Remote Diagnostics in your country, please visit the service/support section of your local website: www.home-connect.com.

8.5 Data protection

Please see the information on data protection.

The first time your appliance is registered on a home network connected to the Internet, your appliance will transmit the following types of data to the Home Connect server (initial registration):

- Unique appliance identification (consisting of appliance codes as well as the MAC address of the Wi-Fi communication module installed).
- Security certificate of the Wi-Fi communication module (to ensure a secure data connection).
- The current software and hardware version of your appliance.
- Status of any previous reset to factory settings.

This initial registration prepares the Home Connect functions for use and is only required when you want to use the Home Connect functions for the first time.

Note: Please note that the Home Connect functions can only be utilised with the Home Connect app. Information on data protection can be retrieved in the Home Connect app.

9 Hob-based hood control

You can connect your appliance to a suitable hob and, in this way, control the functions of your appliance via the hob.

If the hob and the extractor hood are Home Connect-compatible, connect the appliances in the Home Connect app. To do this, connect the two appliances to Home Connect and follow the instructions in the app.

Notes

- Please note the safety precautions in the instruction manual for your appliance and ensure that they are also observed when operating the appliance via the hob-based hood control.
- Operating your appliance always takes priority. It is not possible to use the hob-based hood control during this time.
- You can only connect to the extractor hood via the Home Connect app. Other connection routes are no longer supported.

10 Cleaning and servicing

To keep your appliance working efficiently for a long time, it is important to clean and maintain it carefully.

10.1 Cleaning products

You can obtain suitable cleaning products from after-sales service or the online shop.

WARNING – Risk of electric shock!

An ingress of moisture can cause an electric shock.

- ▶ Before cleaning, pull out the mains plug or switch off the fuse in the fuse box.
- ▶ Do not use steam- or high-pressure cleaners to clean the appliance.

⚠ WARNING – Risk of burns!

The appliance becomes hot during operation.

- ▶ Allow the appliance to cool down before cleaning.

ATTENTION!

Unsuitable cleaning products may damage the surfaces of the appliance.

- ▶ Do not use harsh or abrasive detergents.
- ▶ Do not use cleaning products with a high alcohol content.
- ▶ Do not use hard scouring pads or cleaning sponges.
- ▶ Only use glass cleaners, glass scrapers or stainless steel care products if recommended in the cleaning instructions for the relevant part.
- ▶ Wash sponge cloths thoroughly before use.

10.2 Cleaning the appliance

Clean the appliance as specified. This will ensure that the different parts and surfaces of the appliance are not damaged by incorrect cleaning or unsuitable cleaning products.

⚠ WARNING – Risk of explosion!

Highly caustic alkaline or highly acidic cleaning agents in conjunction with aluminium parts in the interior of the appliance may cause explosions.

- ▶ Never use highly caustic alkaline or highly acidic cleaning agents. In particular, do not use commercial or industrial cleaning agents in conjunction with aluminium parts, e.g. grease filter on extractor hoods.

⚠ WARNING – Risk of electric shock!

An ingress of moisture can cause an electric shock.

- ▶ Before cleaning, pull out the mains plug or switch off the fuse in the fuse box.
- ▶ Do not use steam- or high-pressure cleaners to clean the appliance.

⚠ WARNING – Risk of burns!

The appliance becomes hot during operation.

- ▶ Allow the appliance to cool down before cleaning.

⚠ WARNING – Risk of injury!

Components inside the appliance may have sharp edges.

- ▶ Carefully clean the appliance interior.

If the appliance is operated by another person via the Home Connect app during cleaning, this increases the risk of injury.

- ▶ Before cleaning, disconnect the appliance from the Home Connect app.

1. Observe the information regarding the cleaning agents.

→ "Cleaning products", Page 10

2. Clean as follows, depending on the surface:

- Clean stainless steel surfaces in the direction of the finish using a sponge cloth and hot soapy water.
- Clean painted surfaces using a damp sponge cloth and hot soapy water.
- Clean aluminium using a soft cloth and glass cleaner.
- Clean plastic using a soft cloth and glass cleaner.

- Clean glass using a soft cloth and glass cleaner.

3. Dry with a soft cloth.

4. Apply a thin layer of the stainless steel cleaning product to stainless steel surfaces using a soft cloth.

You can obtain stainless steel cleaning products from the after-sales service or the online shop.

10.3 Cleaning controls and lights**⚠ WARNING – Risk of electric shock!**

Penetrating moisture may cause an electric shock.

- ▶ Do not use wet sponge cloths.

1. Observe the information regarding the cleaning agents.

→ "Cleaning products", Page 10

2. Clean using a damp sponge cloth and hot soapy water.

3. Dry with a soft cloth.

10.4 Removing the grease filter**⚠ WARNING – Risk of injury!**

The filter cover may swing out.

- ▶ Open the filter cover slowly.
- ▶ Take hold of the filter cover after opening until it no longer swings out.
- ▶ Close the filter cover slowly.

Risk of falling when working on the appliance

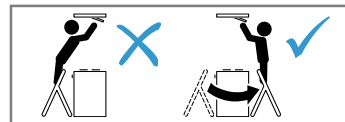

- ▶ Use a stable stepladder.
- ▶ Do not lean over the hob.
- ▶ Do not step on the hob or the work surface.

1. Press the lock on the filter cover.

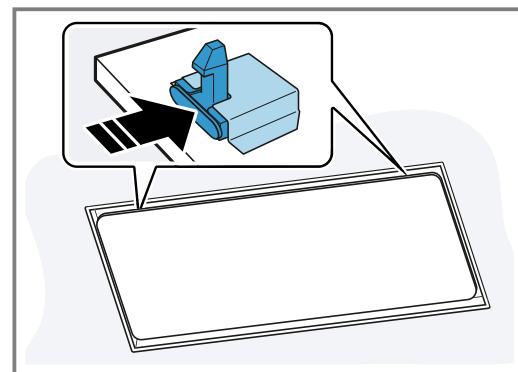

To prevent the filter cover from swinging down suddenly, hold onto the filter cover firmly with two hands.

2. Open the filter cover by pulling it downwards.

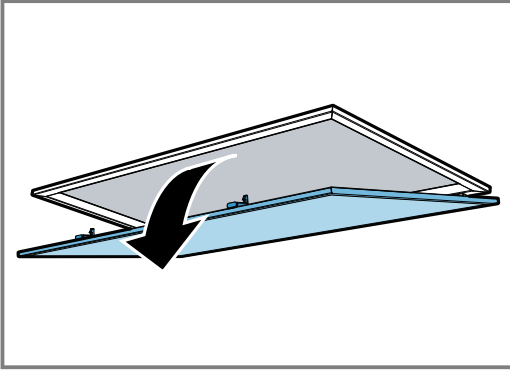

3. ATTENTION!

Falling grease filters may damage the hob below.

- ▶ Grip below the grease filter with one hand.

Open the locks on the grease filters.

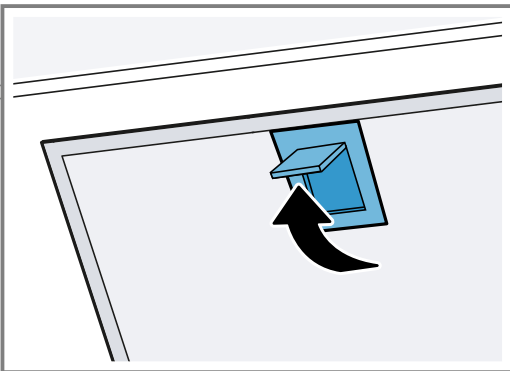

4. Remove the grease filters from the holders.
To prevent grease from dripping, hold the grease filter horizontally.

10.5 Cleaning grease filters manually

The grease filters filter the grease from the cooking vapour. Regularly cleaned grease filters guarantee a high level of grease removal. We recommend cleaning the grease filters every two months.

⚠ WARNING – Risk of fire!

Fatty deposits in the grease filters may catch fire.

- ▶ Clean the grease filters regularly.

Requirement: The grease filters have been removed.
→ "Removing the grease filter", Page 11

1. Observe the information regarding the cleaning agents.
→ "Cleaning products", Page 10
2. Soak the grease filter in hot soapy water.
Use special grease solvent for stubborn dirt. You can obtain grease solvents from customer service or the online shop.
3. Use a brush to clean the grease filters.
4. Rinse the grease filters thoroughly.
5. Allow the grease filters to drain.

10.6 Cleaning grease filters in the dishwasher

The grease filters filter the grease from the cooking vapour. Regularly cleaned grease filters guarantee a high level of grease removal. We recommend cleaning the grease filters every two months.

⚠ WARNING – Risk of fire!

Fatty deposits in the grease filters may catch fire.

- ▶ Clean the grease filters regularly.

ATTENTION!

The grease filters may become damaged if they are squeezed in the dishwasher.

- ▶ Do not squeeze the grease filters.

Note: When cleaning the grease filter in the dishwasher, light discolouration may occur. This discolouration has no effect on the performance of the metal grease filters.

Requirement: The grease filters have been removed.
→ "Removing the grease filter", Page 11

1. Observe the information regarding the cleaning agents.
→ "Cleaning products", Page 10
2. Place the grease filters loosely into the dishwasher.
Do not clean heavily soiled grease filters with utensils.
Use special grease solvent for stubborn dirt. You can obtain grease solvents from customer service or the online shop.
3. Start the dishwasher.
Select a temperature of no more than 70 °C.
4. Allow the grease filters to drain.

10.7 Fitting grease filters

ATTENTION!

Falling grease filters may damage the hob below.

- ▶ Grip below the grease filter with one hand.

1. Fit the grease filters.
2. Fold the grease filters upwards and engage the locks.
3. Make sure that the locks engage.
4. Close the filter cover.
5. Make sure that the filter cover locks engage correctly.

10.8 Replacing the batteries in the remote control

⚠ WARNING – Risk of injury!

Children may swallow batteries.

- ▶ Keep batteries out of the reach of children.
- ▶ Keep an eye on any children when you are replacing batteries.

Batteries may explode.

- ▶ Do not charge the batteries.
- ▶ Do not short-circuit the batteries.
- ▶ Do not throw batteries into a fire.

ATTENTION!

Improper handling of batteries.

- ▶ Do not short-circuit the terminals.
- ▶ Only use the specified type of batteries.
- ▶ Do not use different battery types together.
- ▶ Do not use new and used batteries together.
- ▶ Do not use rechargeable batteries.

Leaking batteries may damage the remote control.

- ▶ Remove the batteries if you are not using the remote control.
- ▶ Safely dispose of empty or defective batteries in an environmentally friendly manner.

1. Remove the cover. ① ②
2. Remove the empty batteries.③

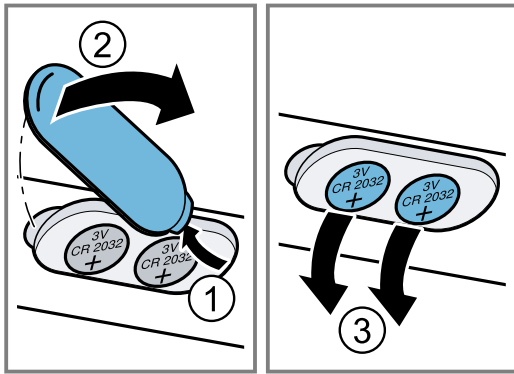

3. Insert the new batteries (3 V CR 2032).①

4. Close the cover. ② ③

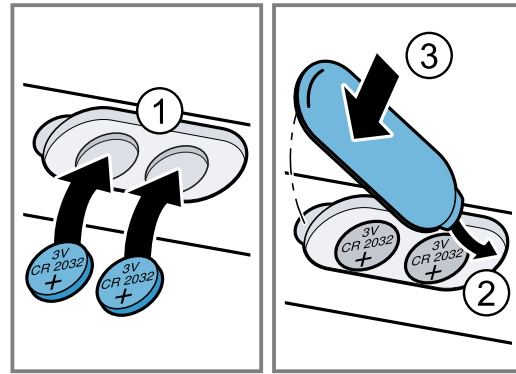

5. Dispose of the empty batteries in an environmentally friendly manner.

11 Troubleshooting

You can rectify minor faults on your appliance yourself. Read the troubleshooting information before contacting after-sales service. This will avoid unnecessary costs.

⚠ WARNING – Risk of injury!

Improper repairs are dangerous.

- ▶ Repairs to the appliance should only be carried out by trained specialist staff.
- ▶ If the appliance is defective, call Customer Service. → "Customer Service", Page 14

⚠ WARNING – Risk of electric shock!

Incorrect repairs are dangerous.

- ▶ Repairs to the appliance should only be carried out by trained specialist staff.
- ▶ Only use genuine spare parts when repairing the appliance.
- ▶ If the power cord of this appliance is damaged, it must be replaced by trained specialist staff.

11.1 Malfunctions

Fault	Cause and troubleshooting
The appliance is not working.	<p>The mains plug of the power cord is not plugged in.</p> <ul style="list-style-type: none"> ▶ Connect the appliance to the power supply. <p>The circuit breaker in the fuse box has tripped.</p> <ul style="list-style-type: none"> ▶ Check the circuit breaker in the fuse box. <p>There has been a power cut.</p> <ul style="list-style-type: none"> ▶ Check whether the lighting in your room or other appliances are working.
The lighting does not work. ¹	<p>Different causes are possible.</p> <ul style="list-style-type: none"> ▶ Call → "Customer Service", Page 14. ▶ Defective LED lights may be replaced by the manufacturer, their customer service or a qualified technician (electrician) only.
Remote control not working.	<p>The batteries are flat.</p> <ul style="list-style-type: none"> ▶ → "Replacing the batteries in the remote control", Page 12
In the LED display, the LEDs flash one to five times after the appliance is switched off.	<p>The batteries are almost empty.</p> <ul style="list-style-type: none"> ▶ → "Replacing the batteries in the remote control", Page 12
The lighting automatically switches on as soon as the appliance is connected to the power supply.	<p>Demo mode is switched on.</p> <ul style="list-style-type: none"> ▶ To deactivate demo mode, press and hold ① and ⏻ for approx. 3 seconds.

¹ Depending on the appliance specifications

Fault	Cause and troubleshooting
LED 1 flashes in the LED display.	The grease filters are saturated. <ul style="list-style-type: none"> ▶ → "Cleaning grease filters in the dishwasher", Page 12 ▶ → "Cleaning grease filters manually", Page 12
LED 2 flashes in the LED display.	The odour filters are saturated. <ul style="list-style-type: none"> ▶ Change the odour filter.
Home Connect is not working properly.	Different causes are possible. <ul style="list-style-type: none"> ▶ Go to www.home-connect.com.

12 Disposal

12.1 Disposing of old appliance

Valuable raw materials can be reused by recycling.

1. Unplug the appliance from the mains.
2. Cut through the power cord.
3. Dispose of the appliance in an environmentally friendly manner.
 Information about current disposal methods are available from your specialist dealer or local authority.



This appliance is labelled in accordance with European Directive 2012/19/EU concerning used electrical and electronic appliances (waste electrical and electronic equipment - WEEE).
 The guideline determines the framework for the return and recycling of used appliances as applicable throughout the EU.

12.2 Disposing of batteries

Batteries should be recycled in an environmentally friendly manner. Do not dispose of the batteries in the household rubbish.

- ▶ Dispose of batteries in an environmentally friendly manner.



According to the European Guideline 2006/66/EC, defective or used battery packs/batteries, must be collected separately and disposed of in an environmentally correct manner.

13 Customer Service

Function-relevant genuine spare parts according to the corresponding Ecodesign Order can be obtained from Customer Service for a period of at least 10 years from the date on which your appliance was placed on the market within the European Economic Area.

Note: Under the terms of the manufacturer's warranty the use of Customer Service is free of charge.

Detailed information on the warranty period and terms of warranty in your country is available from our after-sales service, your retailer or on our website.

If you contact Customer Service, you will require the product number (E-Nr.) and the production number (FD) of your appliance.

The contact details for Customer Service can be found in the enclosed Customer Service directory or on our website.

13.1 Product number (E-Nr.) and production number (FD)

You can find the product number (E-Nr.) and the production number (FD) on the appliance's rating plate. Depending on the model, the rating plate can be found:

- Inside the appliance (remove grease filters for access).
- On top of the appliance.

Make a note of your appliance's details and the Customer Service telephone number to find them again quickly.

14 Accessories

You can buy accessories from the after-sales service, from specialist retailers or online. Only use original accessories, as these have been specifically designed for your appliance.

Accessories vary from one appliance to another. When purchasing accessories, always quote the exact product number (E no.) of your appliance. → Page 14

You can find out which accessories are available for your appliance in our catalogue, in the online shop or from our after-sales service.
www.neff-international.com

Accessories	Order number
Clean Air Standard circulating-air kit, external, stainless steel	Z52JXC1N1
Clean Air Stand. recirc. kit ext. white	Z52JXC1W1
Clean Air standard odour filter (replacement)	Z52JCB1X1

15 Declaration of Conformity

BSH Hausgeräte GmbH hereby declares that the appliance with Home Connect functionality conforms to the basic requirements and other relevant provisions of Directive 2014/53/EU.

A detailed RED Declaration of Conformity can be found online at www.neff-international.com among the additional documents on the product page for your appliance.



Hereby, BSH Hausgeräte GmbH declares that the appliance with Home Connect functionality is in compliance with relevant statutory requirements.¹

A detailed Declaration of Conformity can be found online at www.neff-home.com/uk among the additional documents on the product page for your appliance.¹

**UK
CA**

2.4 GHz band (2400–2483.5 MHz): Max. 100 mW
5-GHz band (5150–5350 MHz + 5470–5725 MHz): max. 50 mW



BE	BG	CZ	DK	DE	EE	IE	EL	ES
FR	HR	IT	CY	LI	LV	LT	LU	HU
MT	NL	AT	PL	PT	RO	SI	SK	FI
SE	NO	CH	TR	IS	UK (NI)			

5 GHz WLAN (Wi-Fi): For indoor use only.

AL	BA	MD	ME	MK	RS	UK	UA
----	----	----	----	----	----	----	----

5 GHz WLAN (Wi-Fi): For indoor use only.

16 Installation instructions



¹ Only applies to Great Britain

16.1 Included with the appliance

After unpacking all parts, check for any damage in transit and completeness of the delivery.

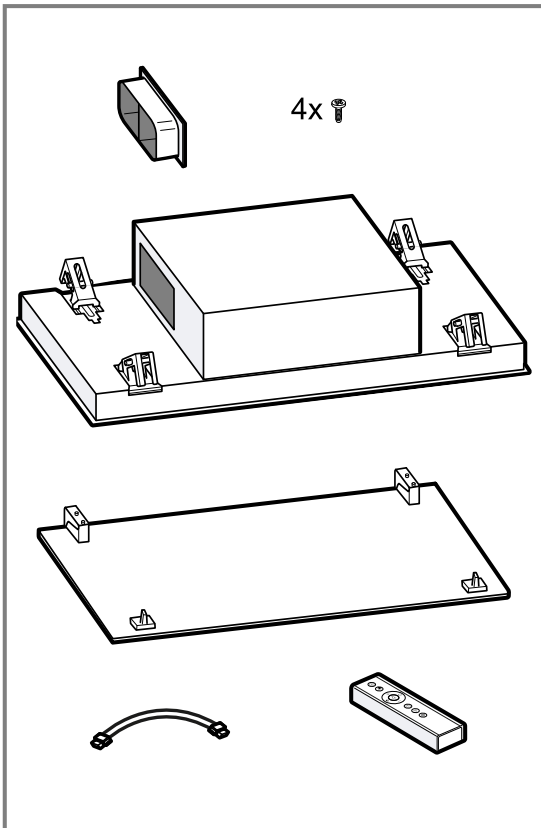

16.2 Dimensions

You will find the dimensions of the appliance here

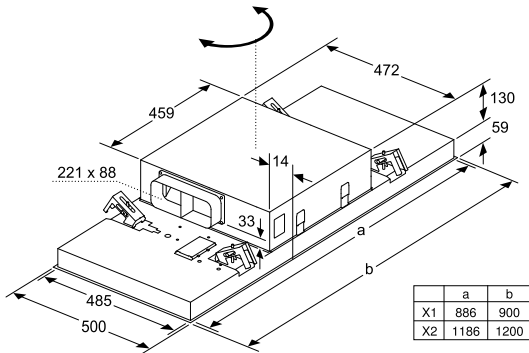

16.3 Safety clearances

Comply with the safety clearances for the appliance.

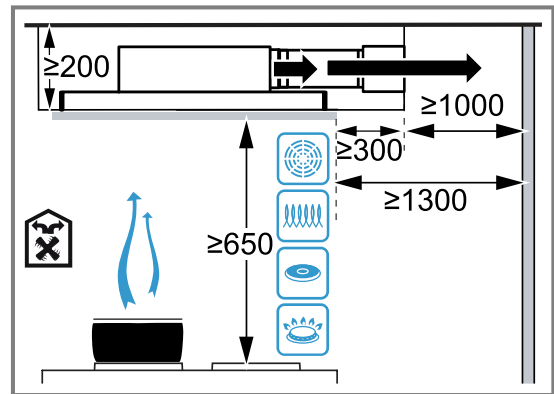
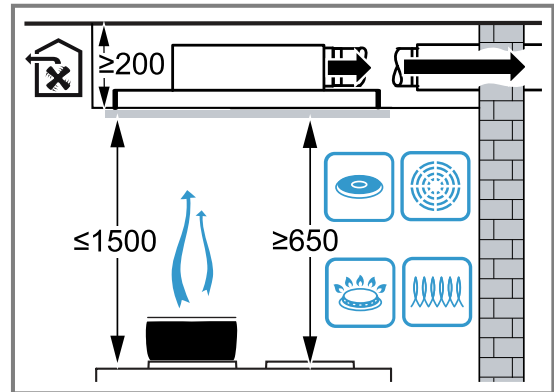

⚠ 16.4 Secure installation

Follow these safety instructions when installing the appliance.

⚠ WARNING – Risk of poisoning!

Risk of poisoning from flue gases being drawn back in. Room-air-dependent heat-producing appliances (e.g. gas, oil, wood or coal-operated heaters, continuous flow heaters or water heaters) obtain combustion air from the room in which they are installed and discharge the exhaust gases into the open through an exhaust gas system (e.g. a chimney). With the extractor hood switched on, air is extracted from the kitchen and the adjacent rooms. Without an adequate supply of air, the air pressure falls below atmospheric pressure. Toxic gases from the chimney or the extraction shaft are sucked back into the living space.

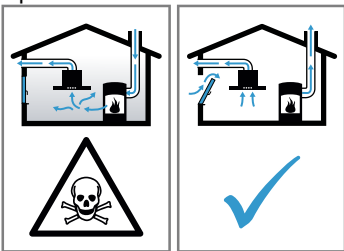

- ▶ Always ensure adequate fresh air in the room if the appliance is being operated in exhaust air mode at the same time as a room-air-dependent heat-producing appliance is being operated.
- ▶ It is only possible to safely operate the appliance if the pressure in the room in which the heating appliance is installed does not fall below 4 Pa (0.04 mbar). This can be achieved whenever the air needed for combustion is able to enter through openings that cannot be sealed, for example in doors, windows, incoming/exhaust air wall boxes or by other technical means. An incoming/exhaust air wall box alone is not sufficient to ensure compliance with the limit.
- ▶ In any case, consult your responsible chimney sweep. They are able to assess the house's entire ventilation setup and will suggest the suitable ventilation measures to you.
- ▶ Unrestricted operation is possible if the appliance is operated exclusively in circulating-air mode.

Risk of poisoning from flue gases being drawn back in.

- ▶ If an extractor hood with an open-flued heat production source is installed, the power supply for the extractor hood must be provided with a suitable safety switch.

Risk of poisoning from flue gases being drawn back in.

- ▶ Do not emit the exhaust air into a smoke or exhaust gas flue that is in operation.
- ▶ Do not emit the exhaust air into a shaft that is used to ventilate installation rooms for heat-producing appliances.
- ▶ If the exhaust air is to be conveyed into a smoke or exhaust gas flue, you must obtain the consent of the heating engineer responsible.

⚠ WARNING – Risk of suffocation!

Children may put packaging material over their heads or wrap themselves up in it and suffocate.

- ▶ Keep packaging material away from children.
- ▶ Do not let children play with packaging material.

⚠ WARNING – Risk of fire!

The grease deposits in the grease filter may catch fire.

- ▶ Never work with naked flames close to the appliance (e.g. flambéing).
- ▶ Do not install the appliance near a heat-producing appliance for solid fuel (e.g. wood or coal) unless a closed, non-removable cover is present. There must be no flying sparks.
- ▶ The specified safety clearances must be complied with in order to prevent a build-up of heat.
- ▶ Observe the specifications for your cooking appliances. If the installation instructions for the cooking appliances specify a different clearance, the larger of the two must always be provided for. If gas hobs and electric hobs are operated together, the largest specified clearance applies.

⚠ WARNING – Risk of injury!

Components inside the appliance may have sharp edges.

- ▶ Wear protective gloves.

The appliance may fall down if it has not been properly fastened in place.

- ▶ All fastening components must be fixed firmly and securely in place.

The appliance is heavy.

- ▶ To move the appliance, two people are required.

- ▶ Use only suitable tools and equipment.

The appliance is heavy.

- ▶ The appliance must not be fitted directly onto plasterboard or similar lightweight materials.

- ▶ To ensure correct installation, you must use a material which is sufficiently stable and suitable for both the structural conditions and the weight of the appliance.

Changes to the electrical or mechanical assembly are dangerous and may lead to malfunctions.

- ▶ Do not make any changes to the electrical or mechanical assembly.

Risk of falling when working on the appliance

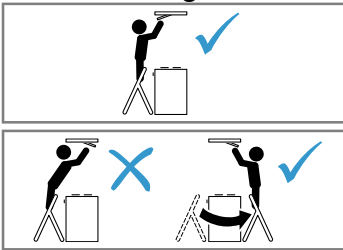

- ▶ Use a stable stepladder.
- ▶ Do not lean over the hob.
- ▶ Do not step on the hob or the work surface.

The filter cover may swing out.

- ▶ Open the filter cover slowly.
- ▶ Take hold of the filter cover after opening until it no longer swings out.
- ▶ Close the filter cover slowly.

Risk of injury when opening and closing the hinges.

- ▶ Keep your hands away from the hinges.

⚠ WARNING – Risk of electric shock!

Sharp-edged components inside the appliance may damage the connecting cable.

- ▶ Do not kink or trap the connecting cable.

If the appliance or the power cord is damaged, this is dangerous.

- ▶ Never operate a damaged appliance.
- ▶ Never pull on the power cord to unplug the appliance. Always unplug the appliance at the mains.

- ▶ If the appliance or the power cord is damaged, immediately unplug the power cord or switch off the fuse in the fuse box.

- ▶ Call customer services. → *Page 14*

Improper repairs are dangerous.

- ▶ Repairs to the appliance should only be carried out by trained specialist staff.
- ▶ Only use genuine spare parts when repairing the appliance.
- ▶ If the power cord of this appliance is damaged, it must be replaced by trained specialist staff.

Incorrect installation is dangerous.

- ▶ Connect and operate the appliance only in accordance with the specifications on the rating plate.
- ▶ Connect the appliance to a power supply with alternating current only via a properly installed socket with earthing.
- ▶ The protective conductor system of the domestic electrical installation must be properly installed.
- ▶ Never equip the appliance with an external switching device, e.g. a timer or remote control.
- ▶ When the appliance is installed, the mains plug of the power cord must be freely accessible. If free access is not possible, an all-pole isolating switch must be installed in the permanent electrical installation according to the conditions of Overvoltage Category III and according to the installation regulations.
- ▶ When installing the appliance, check that the power cable is not trapped or damaged.

16.5 General information

Follow these general instructions during the installation.

- For the installation, observe the currently valid building regulations and the regulations of the local electricity and gas suppliers.
- When discharging the exhaust air, the official and legal regulations, such as the regional building code., must be observed.
- In order to freely access the appliance for servicing, select an easy-to-reach installation site.
- The surfaces of the appliance are sensitive. Avoid damaging them during installation.

16.6 Instructions for the electrical connection

In order to safely connect the appliance to the electrical system, follow these instructions.

⚠ WARNING – Risk of electric shock!

It must always be possible to disconnect the appliance from the electricity supply. The appliance must only be connected to a protective contact socket that has been correctly installed.

- ▶ The mains plug for the mains power cable must be easily accessible after the appliance is installed.
- ▶ If this is not possible, an all-pole isolating switch must be integrated into the permanent electrical installation according to the conditions of overvoltage category III and according to the installation regulations.
- ▶ The permanent electrical installation must only be wired by a professional electrician. We recommend installing a residual-current circuit breaker (RCCB) in the appliance's power supply circuit.

Sharp-edged components inside the appliance may damage the connecting cable.

- ▶ Do not kink or trap the connecting cable.
- The connection data can be found on the rating plate. → *Page 14*
- The connecting cable is approx. 1.30 m long.
- This appliance complies with the EC interference suppression regulations.
- The appliance corresponds to protection class 1. You should therefore only use the appliance with a protective earth connection.
- Do not connect the appliance to the power supply during installation.
- Only a licensed professional may connect appliances without plugs. They are subject to the requirements of the local electricity provider.

16.7 Information on the installation situation

- Install this appliance on the kitchen ceiling or a stable suspended ceiling.
- To install additional special accessory parts, observe the enclosed installation instructions.
- The appliance finds it more difficult to draw in the cooking vapours the further away they are from the hotplate. For optimum performance, a maximum distance of 1500 mm is recommended.
- The width of the extractor hood must correspond at least with the width of the hob.
- To optimally detect the cooking vapours, install the appliance in the middle of the hob.

16.8 Instructions for the exhaust air pipe

The appliance manufacturer does not provide any warranty for faults attributable to the pipeline.

- Use a short, straight exhaust air pipe with as large a pipe diameter as possible.
- Long, rough exhaust air pipes, many pipe bends or small pipe diameters reduce the suction power and increase the fan noise.
- Use an exhaust pipe that is made of non-combustible material.
- To prevent condensate from returning, fit the exhaust pipe with a 1° gradient from the appliance.

Flat ducts

Use flat ducts with an inner cross-section that corresponds to the diameter of the round pipes:

- Diameter of 150 mm corresponds to approx. 177 cm².
- Diameter of 120 mm corresponds to approx. 113 cm².
- Use sealing strips for different pipe diameters.
- Do not use any flat ducts with sharp bends.

Round pipes

Use round pipes with an inner diameter of 150 mm (recommended) or at least 120 mm.

16.9 Installation**Checking the ceiling**

1. Check whether the ceiling is horizontal and adequately load-bearing. The maximum weight of the appliance is 40 kg. Do not fit the appliance directly onto plasterboard (or similar lightweight materials) in a suspended ceiling.
2. Drill the hole depth in accordance with the length of the screws.
3. Install the appliance with a fixing material which is sufficiently stable and has been adjusted accordingly for both the structural conditions and the weight of the appliance.
4. Check the cut-out area for existing cables of other appliances.

Preparing the ceiling

1. Ensure that the stability of the ceiling is guaranteed after the cut-outs have been made.
2. Cover the hob to prevent damage.
3. Saw a cut-out into the ceiling.

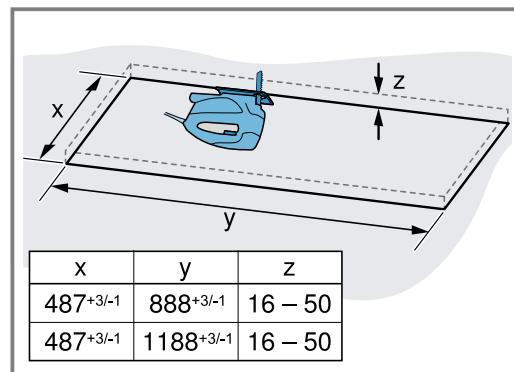

4. Remove any shavings.

Preparing the appliance

1. Remove the grease filters. To avoid causing damage, do not bend the grease filters.

2. Screw the flat duct connection onto the fan group.

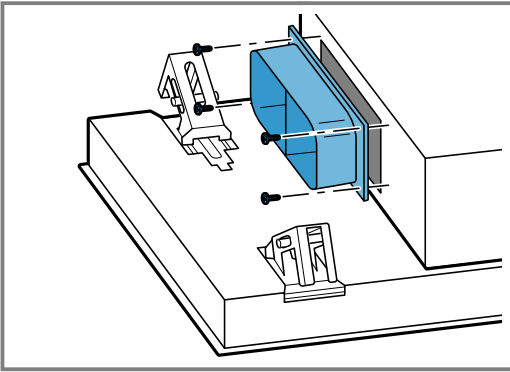

Installing the appliance

⚠ WARNING – Risk of injury!

Components inside the appliance may have sharp edges.

- ▶ Wear protective gloves.
- The appliance is heavy.
- ▶ To move the appliance, two people are required.
- ▶ Use only suitable tools and equipment.

1. Insert the appliance into the cut-out until you hear the mounting brackets engage.

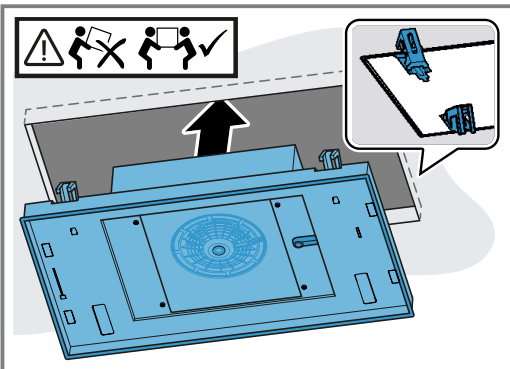

2. Carefully screw in diagonally opposite screws.

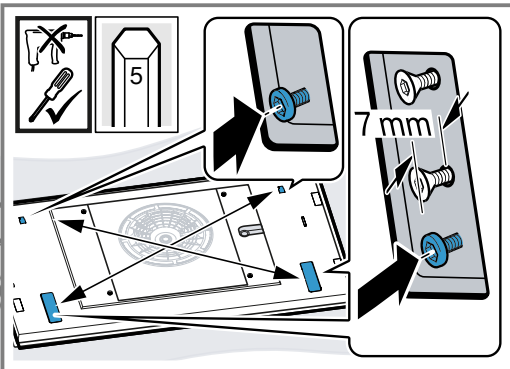

Tighten the screws one at a time so that the appliance is not wedged in the cut-out.

3. **Note:** To ensure that the appliance is not damaged, do not overtighten the screws.

Carefully tighten screws in succession until the appliance is flush-mounted on the ceiling.

Connecting the appliance

1. Undo the screws on the top frame assembly using a screwdriver and remove the top frame assembly.

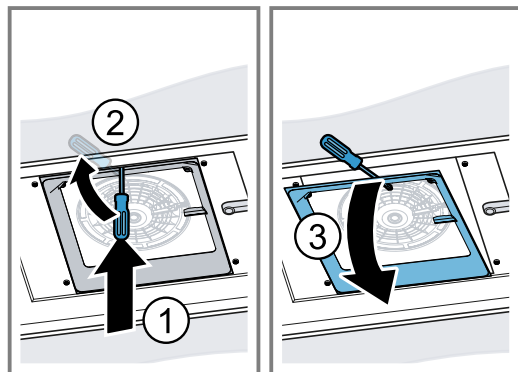
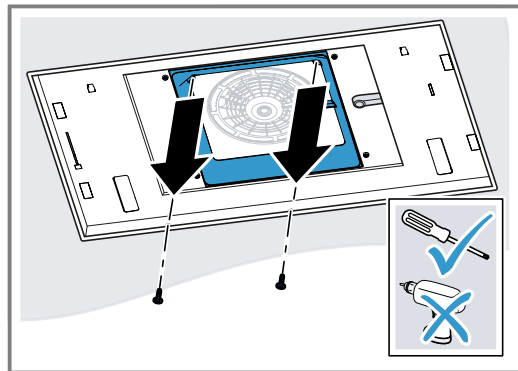

2. Press together the cable duct at the sides and remove it.

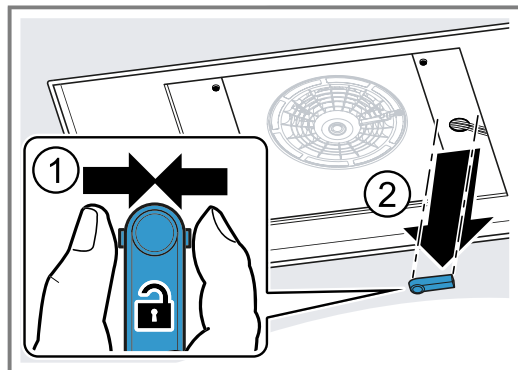

3. Disconnect the cable at the appropriate point.

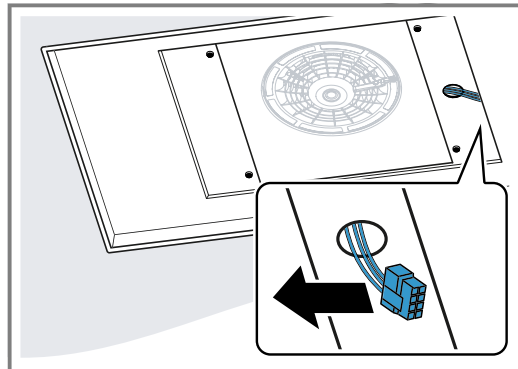

- Loosen the screws on the side covers and remove the covers.

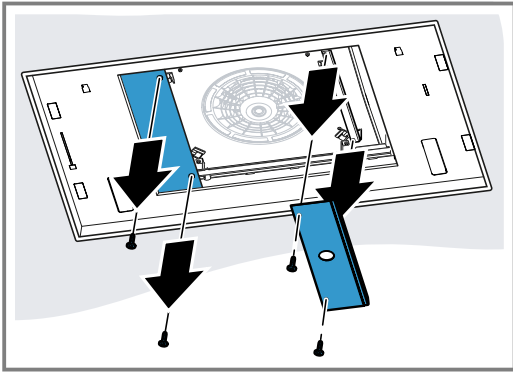

- Undo the opposite screws to loosen the fan box.

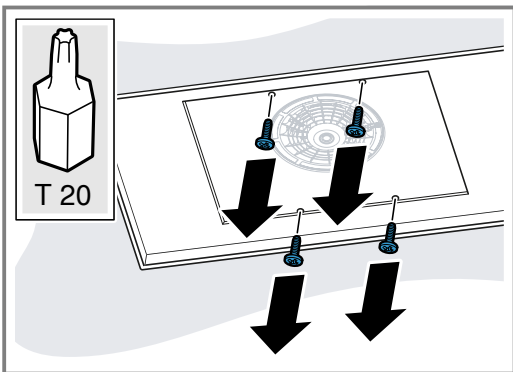

- Push the fan box to the side and connect the appliance to the power supply.

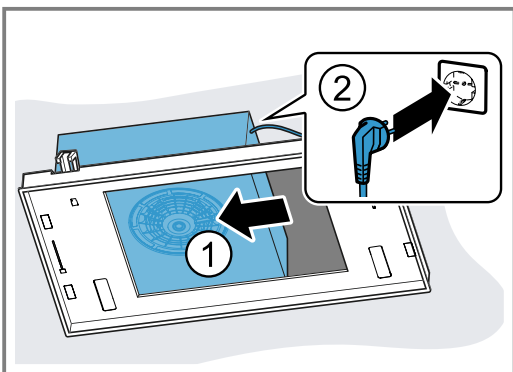

- Push the fan box to the other side and connect the pipework.

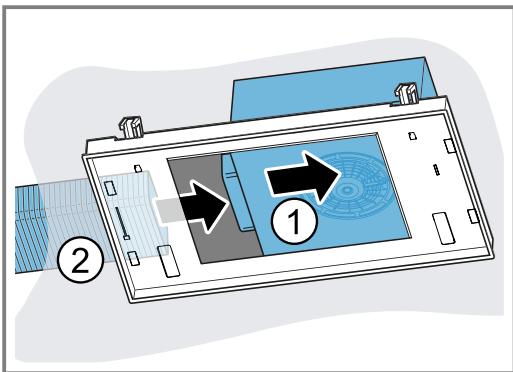

- Position the fan box in the centre and screw it firmly in place.

Installation variants of the fan box

The fan box can be rotated according to the installation situation.

Turning the air outlet to the back

- Starting with the delivery condition, turn the fan box clockwise so that the air outlet is pointing to the back.
- Insert the extension cable.
- Hook the cable into the cable guides 1 and 2.

Turning the air outlet to the front

- Starting with the delivery condition, turn the fan box anti-clockwise so that the air outlet is pointing to the front.
- Undo the screw on the metal hook.

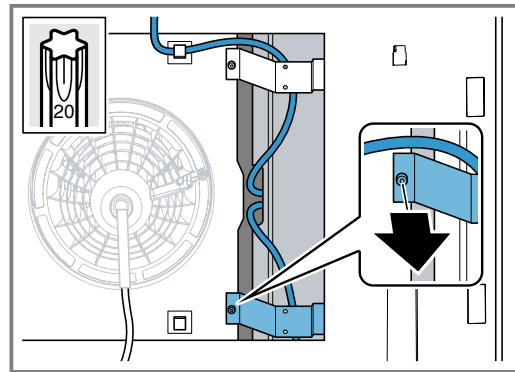

- Pull the cable through behind the metal hook and hook it in the cable guides.
- Store the remaining cable in the gap.

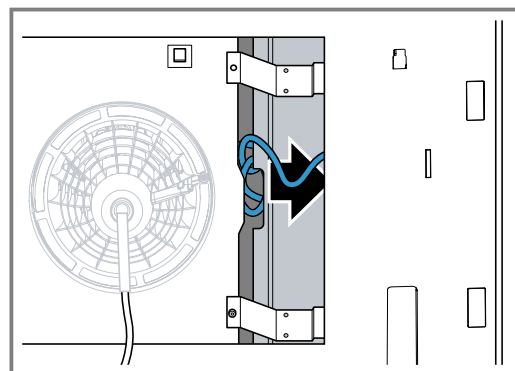

- Tighten the screw on the metal hook so that it is firmly in place.

Turning the air outlet clockwise

- Ausgehend vom Auslieferungszustand, den Lüfterkasten im Uhrzeigersinn drehen, sodass der Luftauslass nach rechts zeigt.
- Undo the screw on the metal hook.

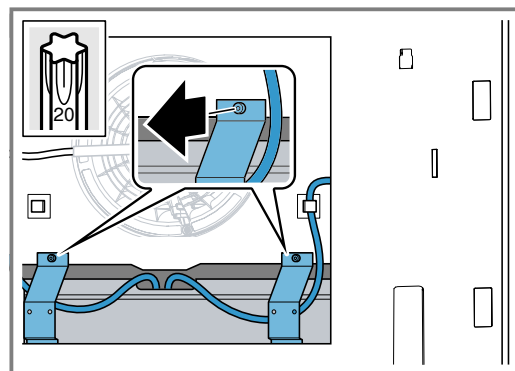

- Das Kabel durch den Metallhaken ziehen.
- Das Kabel in die Kabelführung 4 einhängen.
- Tighten the screw on the metal hook so that it is firmly in place.

Finishing connecting the appliance

1. Guide the cable through the opening in the side cover.
2. Insert the side covers and screw them firmly in place.

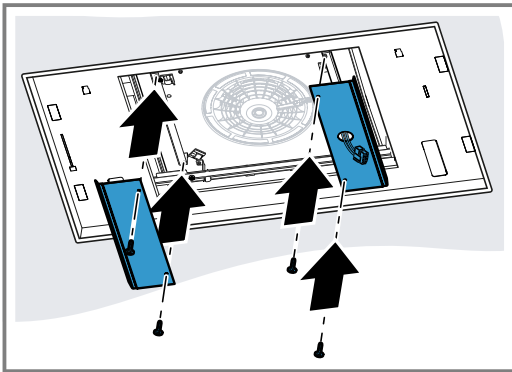

3. Connect the cable.

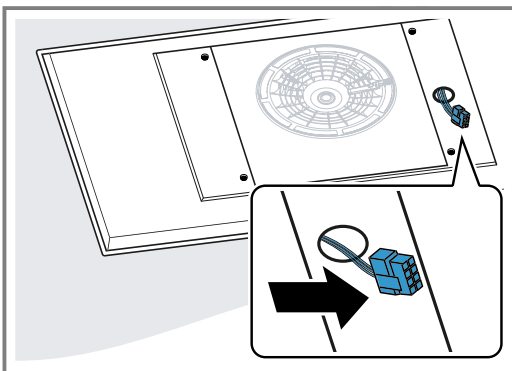

4. Press together the cable duct at the sides and attach.

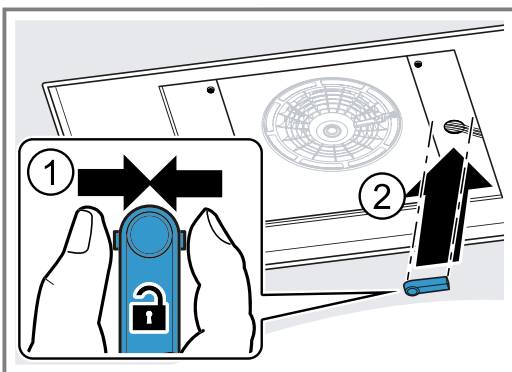

5. Fit the cover frame and screw it firmly in place.

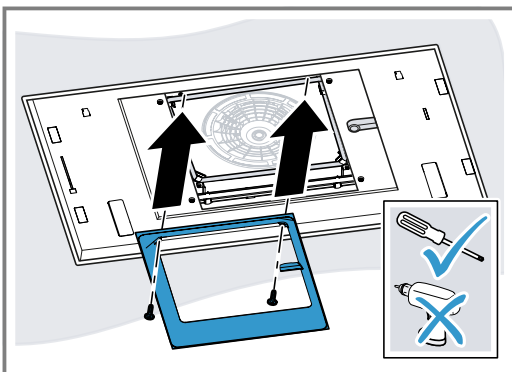

Fitting the filter cover

⚠ WARNING – Risk of injury!

Components inside the appliance may have sharp edges.

- ▶ Wear protective gloves.
- Risk of injury when opening and closing the hinges.
- ▶ Keep your hands away from the hinges.

1. Open the hinges on the filter cover.

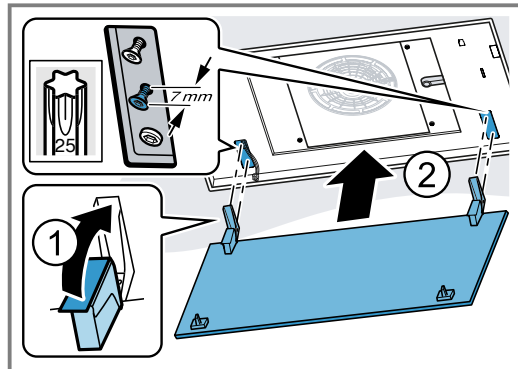

2. Mount the filter cover on the designated screws and push it backwards/forwards depending on the key hole opening into the narrow section.

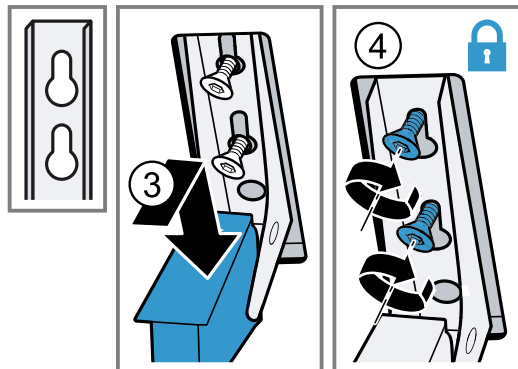

3. Tighten the fastening screws on the hinges.
4. Check whether the appliance frame is lying flush.

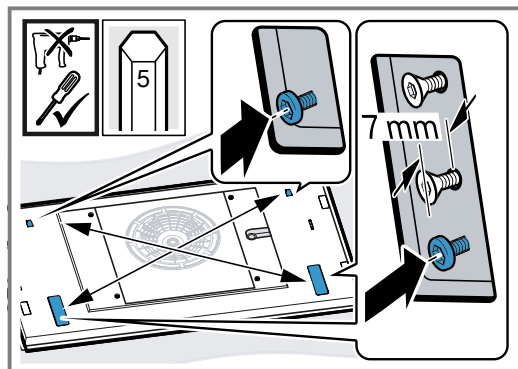

Retighten the screws if necessary.

5. Fit the grease filters.
To avoid causing damage, do not bend the grease filters.
6. Swing the filter cover up and ensure that it engages.

Removing the appliance

⚠ WARNING – Risk of injury!

The appliance is heavy.

- ▶ To move the appliance, two people are required.
- ▶ Use only suitable tools and equipment.

Components inside the appliance may have sharp edges.

► Wear protective gloves.

Risk of injury when opening and closing the hinges.

► Keep your hands away from the hinges.

1. Disconnect the appliance from the power supply.
2. Remove the grease filters.
To avoid causing damage, do not bend the grease filters.
3. Open the cable duct on the filter cover and loosen the cable.
4. Undo the screws on the hinges up to approx. 7 mm. Do not loosen the screws fully.
5. Unhook and remove the filter cover.
6. Undo the screws on the top frame assembly using a screwdriver and remove the top frame assembly.

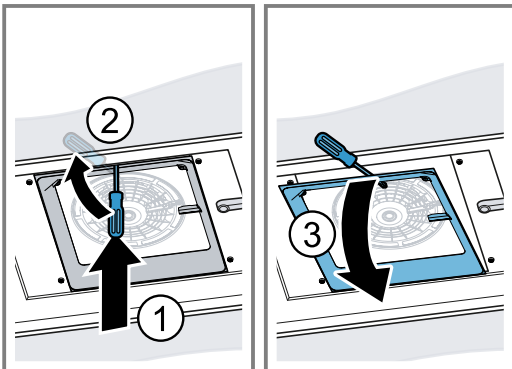
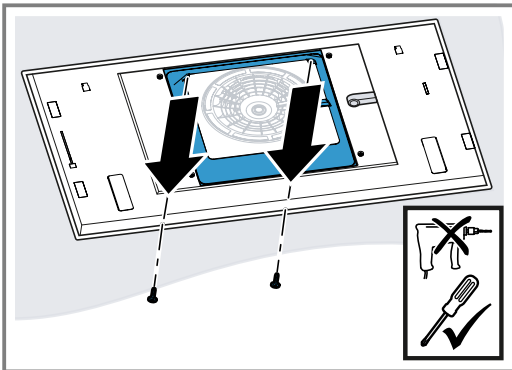

7. Loosen the screws on the side covers and remove the covers.

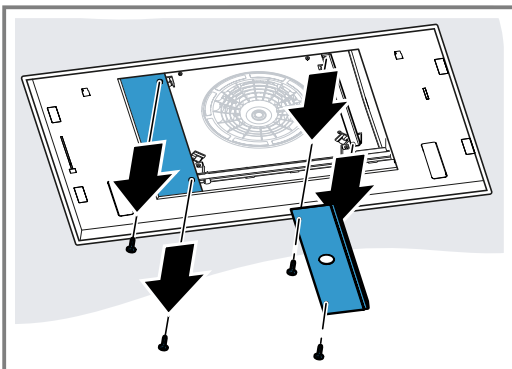

8. Press together the cable duct at the sides and remove it.

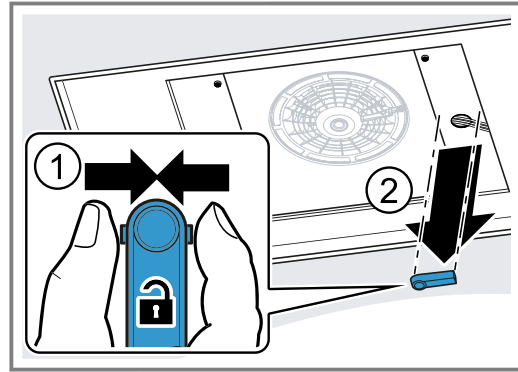

9. Disconnect the cable at the appropriate point.

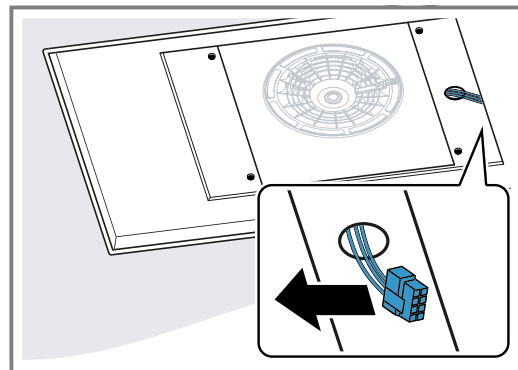

10. Undo the opposite screws to loosen the fan box.

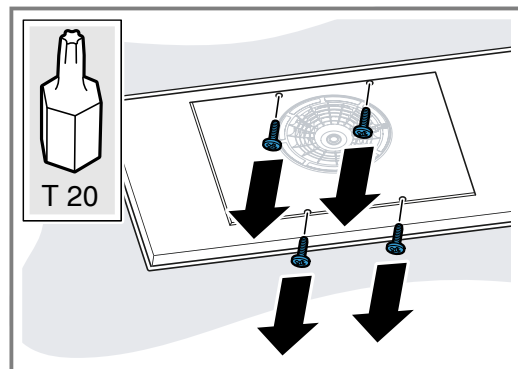

11. Push the fan box to the side and release the pipework.

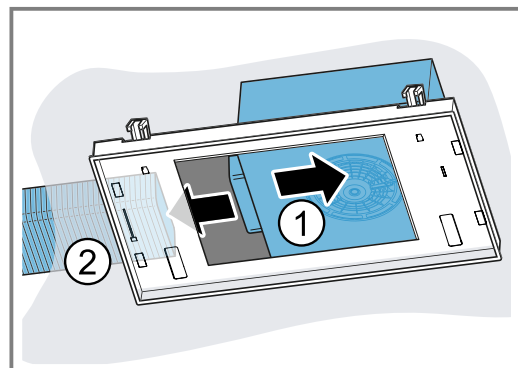

12. Push the fan box to the other side and pull out the mains plug.

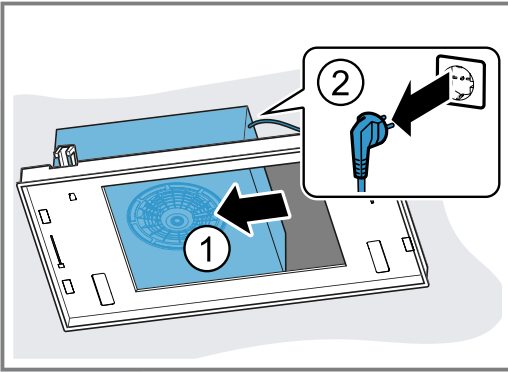

13. Rotate the fan box in such a way that the air outlet faces forwards.

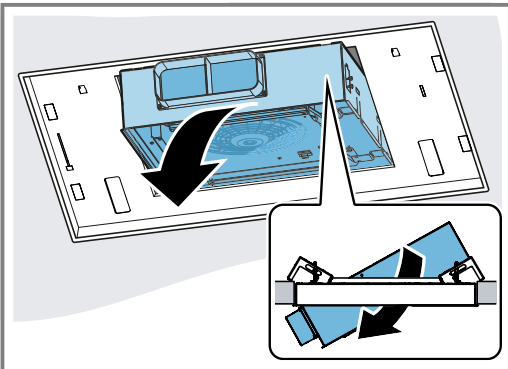

14. Remove the fan box.

15. Loosen the mounting brackets on the appliance using a screwdriver.

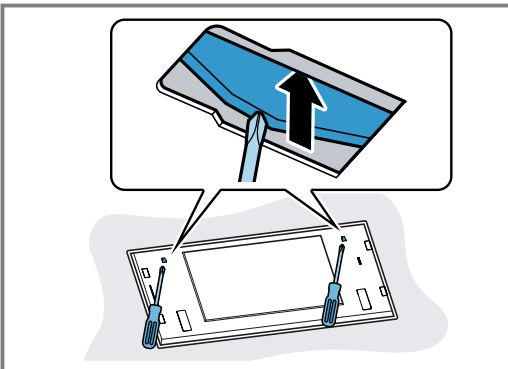

16. Slowly take the appliance out of the cutout.

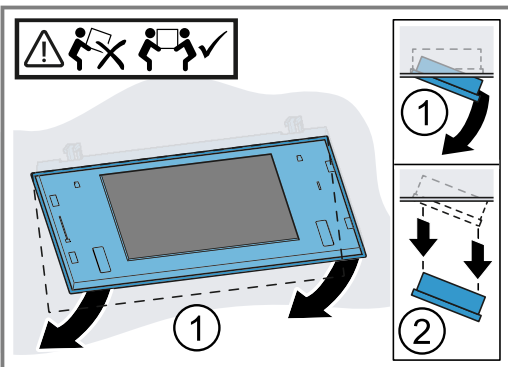



A series of horizontal lines for writing, starting with a solid line at the top and followed by multiple dashed lines, providing a guide for letter height and placement.

Valid within Great Britain:
Imported to Great Britain by
BSH Home Appliances Ltd.
Grand Union House
Old Wolverton Road
Wolverton, Milton Keynes
MK12 5PT
United Kingdom



Register your product online
neff-home.com

BSH Hausgeräte GmbH
Carl-Wery-Straße 34
81739 München, GERMANY



9001482617
031026
en

